

51系列平开窗结构图

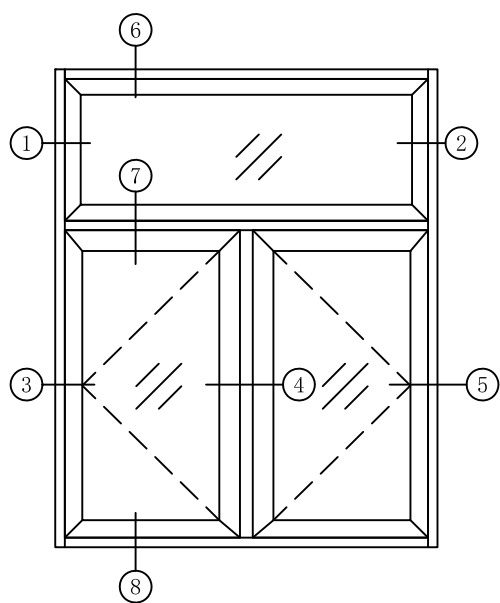

标准窗: 1.5mX1.5m, 耗材约5.4kg/m²。

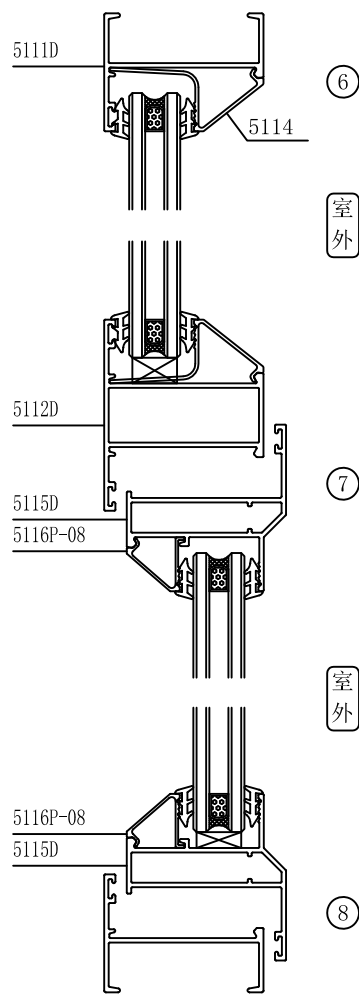

室外

室外

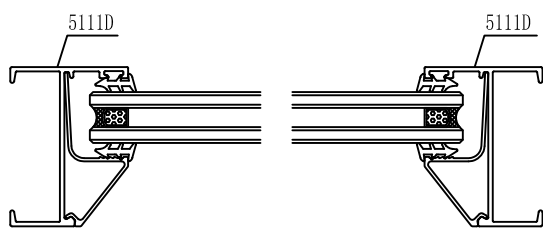

①

室外

②

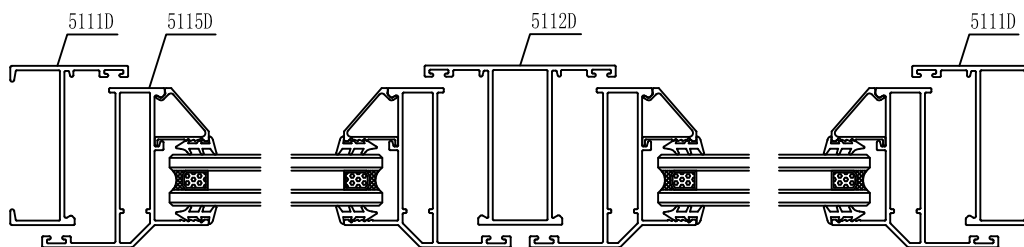

③

室外

④

室外

⑤



51系列平开窗型材目录

型材编号	图 例	型材编号	图 例	型材编号	图 例
名称		名称		名称	
壁厚T(mm)		壁厚T(mm)		壁厚T(mm)	
重量(kg/m)		重量(kg/m)		重量(kg/m)	
5111C 窗框 T=1.2 0.413 kg/m		5121 窗框 T=1.3 0.507 kg/m		51183 中柱 T=1.4 0.911 kg/m	
5111D 窗框 T=1.4 0.459 kg/m		5121A 窗框 T=1.4 0.539 kg/m		51113 滴水中柱 T=1.3 0.801 kg/m	
5111G-1.4 窗框 T=1.4 0.529 kg/m		5165-14 窗框 T=1.4 0.678 kg/m		5112E 中挺 T=1.3 0.791 kg/m	
5111-2.0 窗框 T=2.0 0.594 kg/m		5112C 中挺 T=1.2 0.680 kg/m		51186 中挺 T=1.4 0.843 kg/m	
51185 窗框 T=1.4 0.485 kg/m		5112 中挺 T=1.3 0.720 kg/m		5124C-14 反向中挺 T=1.4 0.759 kg/m	
51141 窗框 T=1.2 0.459 kg/m		5112F-12 中挺 T=1.2 0.740 kg/m		5139 加强中挺 T=1.4 0.970 kg/m	
51197 窗框 T=1.4 0.528 kg/m		5112F-14 中挺 T=1.4 0.827 kg/m		51111-1.4 加强中挺 T=1.4 1.177 kg/m	
51160-14 窗框 T=1.4 0.535 kg/m		5112D 中挺 T=1.4 0.758 kg/m		5178-14 加强中挺 T=1.4 1.072 kg/m	

51系列平开窗型材目录

型材编号	图 例	型材编号	图 例	型材编号	图 例
名称		名称		名称	
壁厚T(mm)		壁厚T(mm)		壁厚T(mm)	
重量(kg/m)		重量(kg/m)		重量(kg/m)	
5180-14 加强中挺 T=1.4 1.299 kg/m		5114 框压线 T=1.0 0.210 kg/m		51187P 框压线 T=1.0 0.238 kg/m	
51178 中柱 T=1.4 1.237 kg/m		5195P-10 框压线 T=1.0 0.216 kg/m		5115 窗扇 T=1.2 0.588 kg/m	
51191 加强中挺 T=1.7 1.369 kg/m		5163-0.9 框压线 T=0.9 0.221 kg/m		5115D 窗扇 T=1.4 0.661 kg/m	
5120B 框压线 T=0.9 0.189 kg/m		5137-0.8 框压线 T=0.8 0.194 kg/m		5167-13 窗扇 T=1.3 0.616 kg/m	
5120-0.8 框压线 T=0.8 0.173 kg/m		5137 框压线 T=1.0 0.240 kg/m		5130 窗扇 T=1.35 0.869 kg/m	
5120 框压线 T=1.0 0.210 kg/m		51170P 框压线 T=1.0 0.240 kg/m		51168 窗扇 T=1.4 0.808 kg/m	
5120P-1.0 框压线 T=1.0 0.213 kg/m		5128 框压线 T=1.0 0.238 kg/m		5198 门扇 T=2.0 0.851 kg/m	
5186-10 框压线 T=1.0 0.211 kg/m		51190P 框压线 T=1.0 0.238 kg/m		5119B 扇压线 T=0.9 0.173 kg/m	

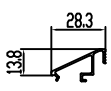
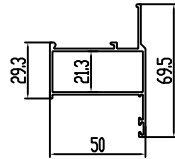
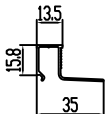
51系列平开窗型材目录

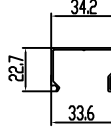
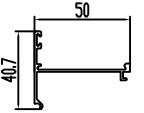
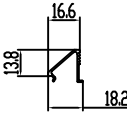
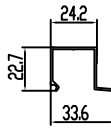
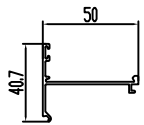
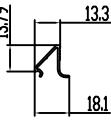
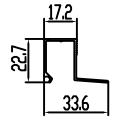
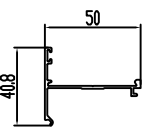
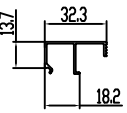
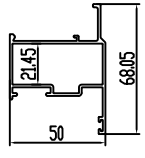
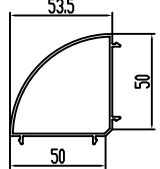
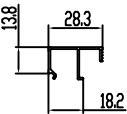
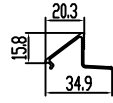
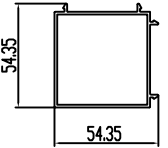
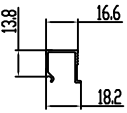
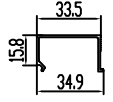
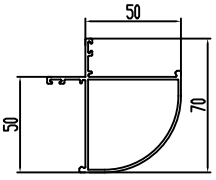
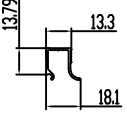
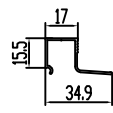
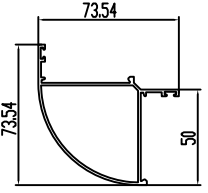
型材编号	图 例	型材编号	图 例	型材编号	图 例
名称		名称		名称	
壁厚T(mm)		壁厚T(mm)		壁厚T(mm)	
重量(kg/m)		重量(kg/m)		重量(kg/m)	
5119A 扇压线 T=0.8 0.151 kg/m		51136 窗扇 T=1.4 0.789 kg/m		51188P 扇压线 T=1.0 0.206 kg/m	
	槽口:13mm		配角码: ZYP50M11		槽口:30mm
5185-10 扇压线 T=1.0 0.140 kg/m		51137P 扇压线 T=1.0 0.235 kg/m		5196-12 转换框 T=1.2 0.375 kg/m	
	槽口:21mm		槽口:10.5mm		
5116P-08 扇压线 T=0.8 0.111 kg/m		51138P 扇压线 T=1.0 0.218 kg/m		5196-13 转换框 T=1.3 0.393 kg/m	
	槽口:24.7mm		槽口:21mm		
51159P-9 扇压线 T=0.9 0.115 kg/m		51192P 扇压线 T=1.0 0.217 kg/m		51198 转换框 T=1.2 0.379 kg/m	
	槽口:28mm		槽口:28mm		注: 仅配51197
5162-0.9 扇压线 T=0.9 0.192 kg/m		5192-14 窗扇 T=1.4 0.851 kg/m		5124D 90° 转角 T=1.4 0.764 kg/m	
	槽口:9mm		配角码: C6038		
5138 扇压线 T=0.9 0.189 kg/m		5181-10 扇压线 T=1.0 0.176 kg/m		5124F 转角 T=1.4 0.808 kg/m	
	槽口:13mm		槽口:23.2mm		
5129 扇压线 T=0.9 0.143 kg/m		5183-11 扇压线 T=1.1 0.220 kg/m		5159-1.4 90° 转角 T=1.4 0.929 kg/m	
	槽口:24.7mm		槽口:10mm		
5194P-10 扇压线 T=1.0 0.143 kg/m		51189P 扇压线 T=1.0 0.195 kg/m		5125C-14 90° 转角 T=1.4 0.956 kg/m	
	槽口:28mm		槽口:26.5mm		

